

Product data sheet

Miniature connectors



Product description	M16 IP40 male panel mount connector, Contacts: 14, unshielded, dip-solder, IP40, front mounting
Area	M16 IP40 series 680
Order number	09 0053 90 14

Illustration



Scale drawing

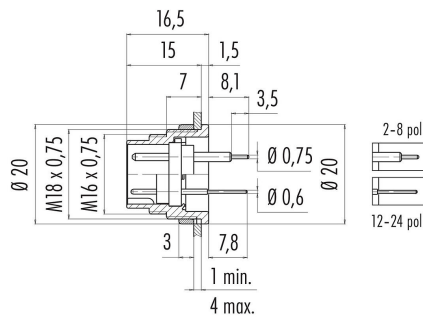

Contact arrangement (Plug-in side)

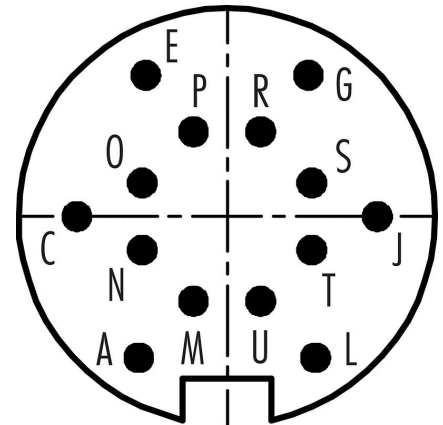

You can find the assembly instructions on the next page.

Technical data

General features

Order number	09 0053 90 14
Connector design	male panel mount connector
Version	connector male straight
Connector locking system	screw
Termination	dip-solder
Degree of protection	IP40
Temperature range from/to	-40 °C / 85 °C
Mechanical operation	> 500 Mating cycles
Weight (g)	11.726
Customs tariff number	85369010

Electrical parameters

Rated voltage	60 V
Rated impulse voltage	500 V
Rated current (40 °C)	3 A
Insulation resistance	$\geq 10^{10} \Omega$
Pollution degree	1
Overvoltage category	I
Insulating material group	III
EMC compliance	unshielded

Product data sheet

Miniature connectors



Product description	M16 IP40 male panel mount connector, Contacts: 14, unshielded, dip-solder, IP40, front mounting
Area	M16 IP40 series 680
Order number	09 0053 90 14

Material

Housing material	Zinc die-cast nickel-plated
Contact body material	PBT (UL94 V-0)
Contact material	CuZn (brass)
Contact plating	Au (gold)
REACH SVHC	CAS 7439-92-1 (Lead)

Classifications

eCl@ss 11.1	27-44-01-09
ETIM 7.0	EC003569

Product data sheet
Miniature connectors



Product description	M16 IP40 male panel mount connector, Contacts: 14, unshielded, dip-solder, IP40, front mounting
Area	M16 IP40 series 680
Order number	09 0053 90 14

Product data sheet
Miniature connectors



Product description	M16 IP40 male panel mount connector, Contacts: 14, unshielded, dip-solder, IP40, front mounting
Area	M16 IP40 series 680
Order number	09 0053 90 14

Product description	M16 IP40 male panel mount connector, Contacts: 14, unshielded, dip-solder, IP40, front mounting
Area	M16 IP40 series 680
Order number	09 0053 90 14

Assembly instructions / Panel cut-out

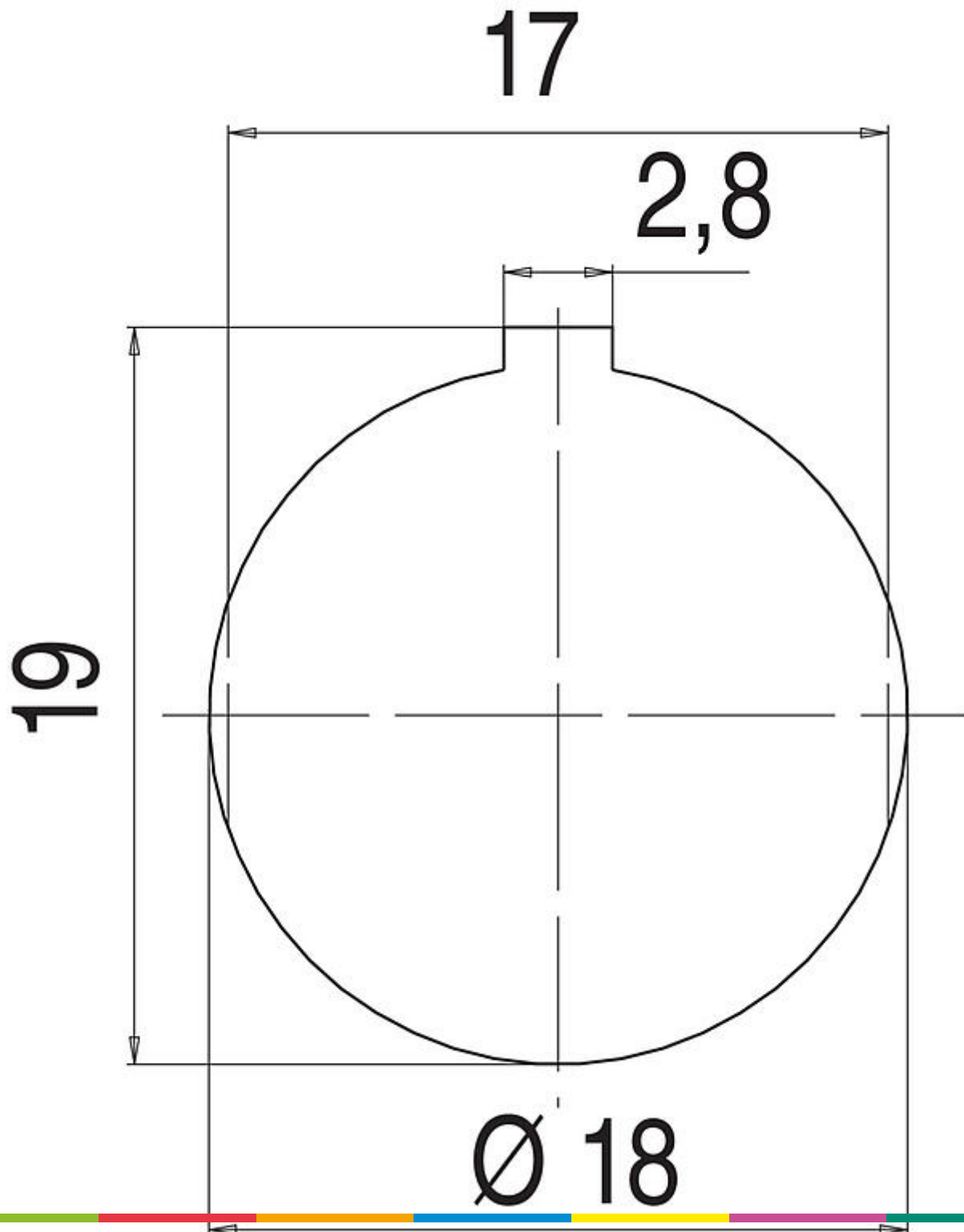

Product data sheet

Miniature connectors



Product description	M16 IP40 male panel mount connector, Contacts: 14, unshielded, dip-solder, IP40, front mounting
Area	M16 IP40 series 680
Order number	09 0053 90 14

Security notices

The connectors have been developed for applications in plant engineering, control and electrical equipment construction. The user is responsible for checking whether the connectors can also be used in other areas of application.