

Product data sheet

Subminiature connectors



Product description	Push-Pull female panel mount connector, Contacts: 8, shieldable, solder, IP67
Area	Push-Pull series 430
Part no.	09 4932 00 08

Illustration



Scale drawing

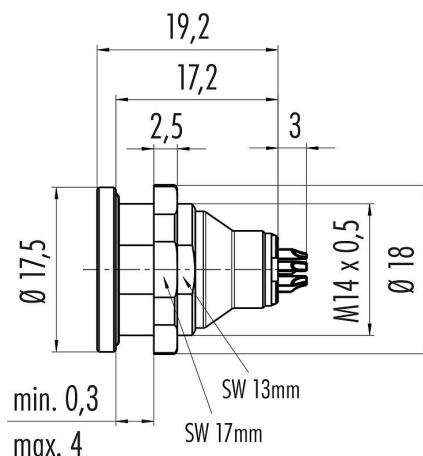

Contact arrangement (Plug-in side)

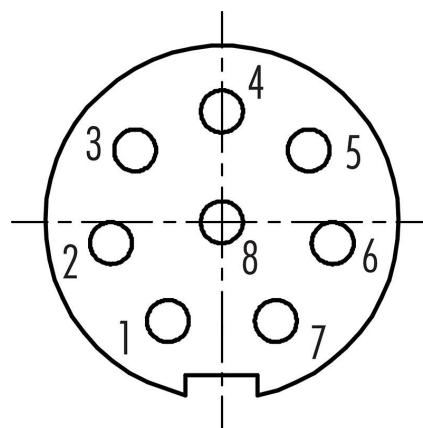

You can find the component part drawing and assembly instructions on the next page.

Technical data

General features

Part no.	09 4932 00 08
Connector design	female panel mount connector
Version	connector female straight
Connector locking system	Push-Pull
Termination	solder
Degree of protection	IP67
Cross-sectional area	0.14 mm ² / AWG 26
Temperature range from/to	-40 °C / 85 °C
Mechanical operation	> 500 Mating cycles
Weight (g)	10.04
Customs tariff number	85369010

Electrical parameters

Rated voltage	125 V
Rated impulse voltage	1500 V
Rated current (40 °C)	1 A
Pollution degree	2
Overvoltage category	I
Insulating material group	II
EMC compliance	shieldable

Product data sheet

Subminiature connectors

Product description **Push-Pull female panel mount connector, Contacts: 8, shieldable, solder, IP67**

Area **Push-Pull series 430**
Part no. **09 4932 00 08**

Shield connection

Shielding on the housing

Material

Contact body material	PUR/PA
Contact material	CuSn (bronze)
Contact plating	Au (gold)
REACH SVHC	CAS 7439-92-1 (Lead)
SCIP number	SCIP-number not available

Classifications

eCl@ss 11.1	27-44-01-09
ETIM 7.0	EC003569

Component part drawing

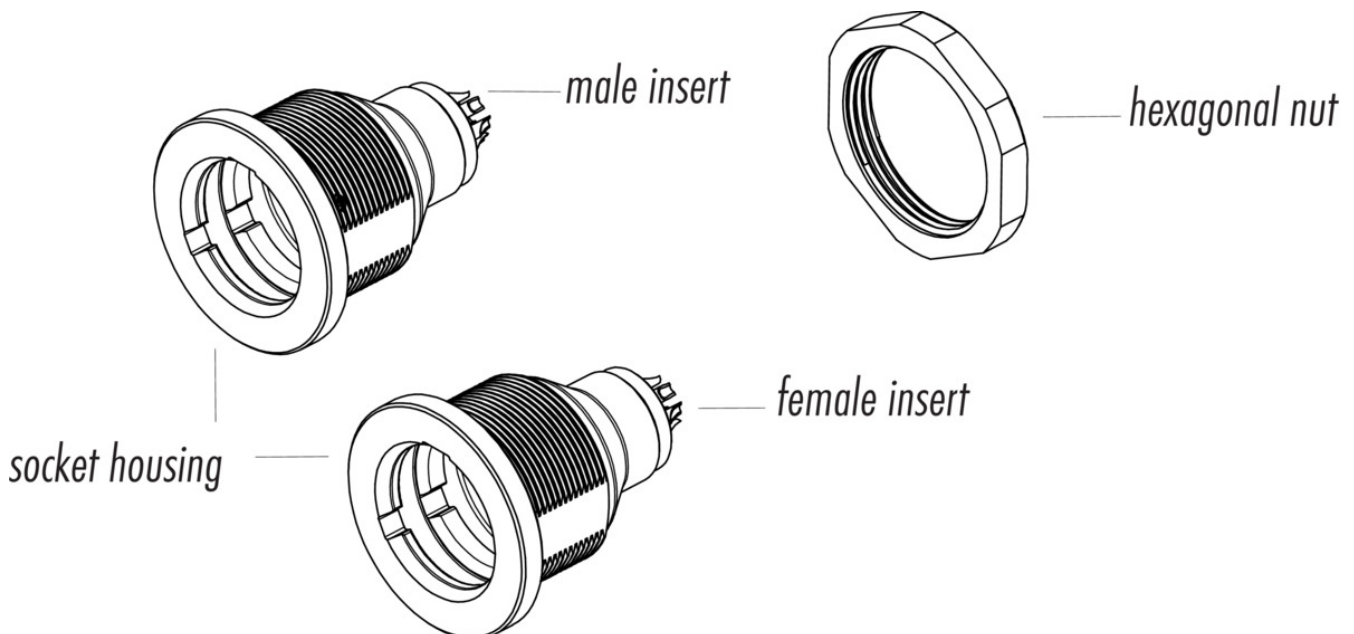

Product description	Push-Pull female panel mount connector, Contacts: 8, shieldable, solder, IP67
Area	Push-Pull series 430
Part no.	09 4932 00 08

Assembly instructions / Panel cut-out

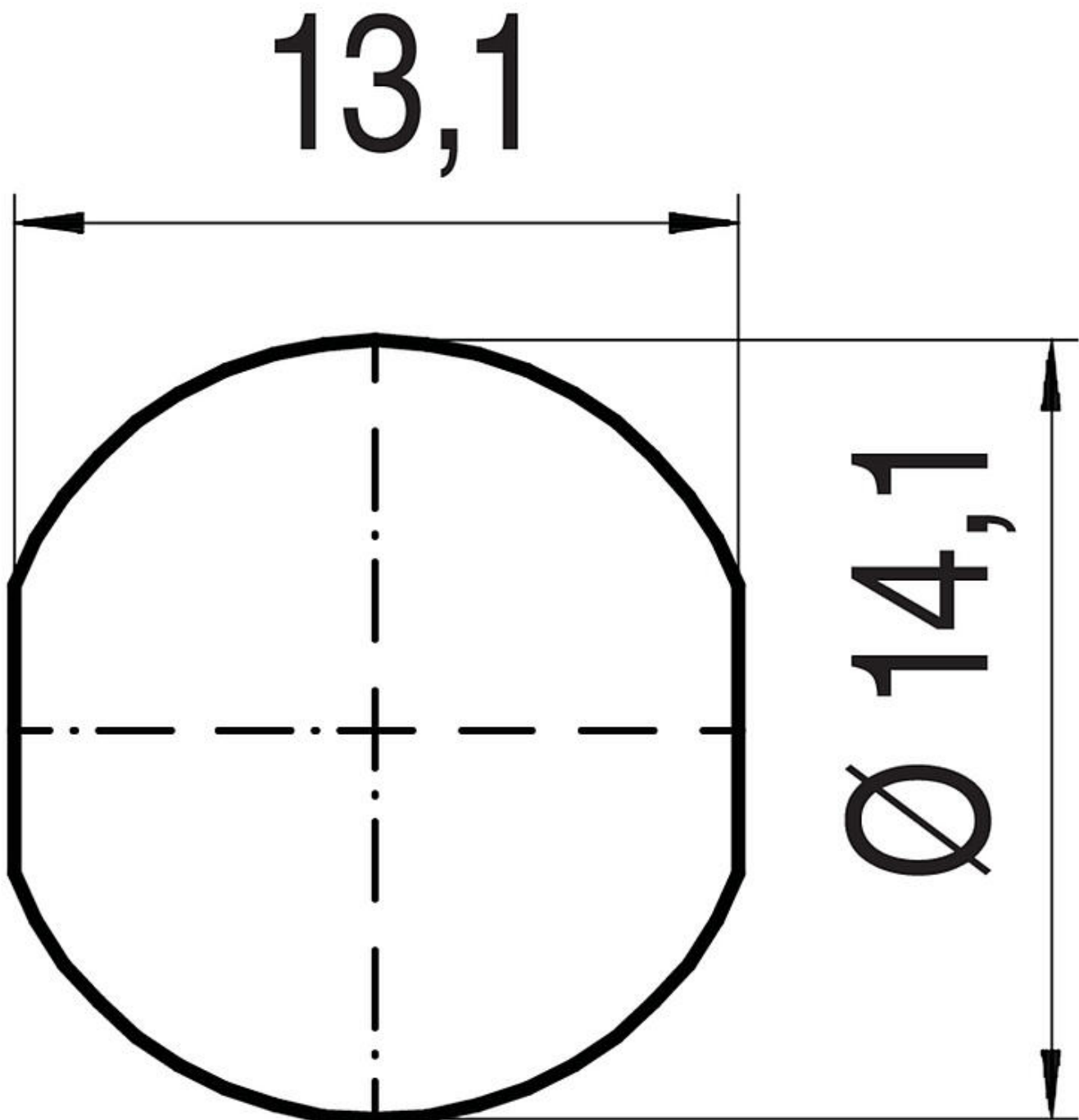

Product description	Push-Pull female panel mount connector, Contacts: 8, shieldable, solder, IP67
Area Part no.	Push-Pull series 430 09 4932 00 08

Security notices

The connector must not be plugged or unplugged under load. Non-observance and improper use can result in personal injury.

The connectors have been developed for applications in plant engineering, control and electrical equipment construction. The user is responsible for checking whether the connectors can also be used in other areas of application.

Connectors which are used in circuits with voltages dangerous to the touch may only be installed and used by, or under the supervision of, persons with electrical engineering training, taking into account the applicable regulations and standards.

Plug connectors with enclosure protection IP 67 and IP 68 are not suitable for use under water. When used outdoors, the plug connectors must be protected separately against corrosion. For further information on the IP protection classes, please refer to the "Technical Information" download centre.