

Product description	Size A female connector (panel mount), Contacts: 2+PE, 3.0 - 10.0 mm, unshielded, screw clamp, IP40 without seal, VDE, ESTI+
Area	Size A series 210
Part no.	43 1704 004 03

Illustration

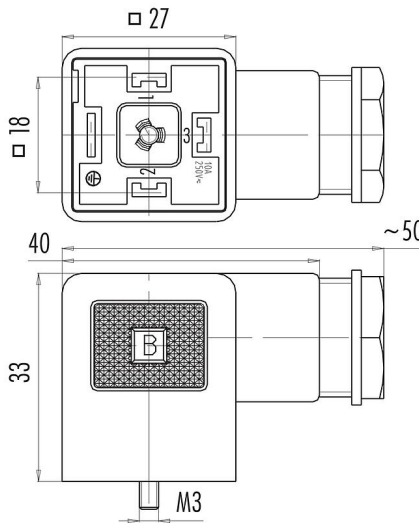

Scale drawing



Contact arrangement (Plug-in side)

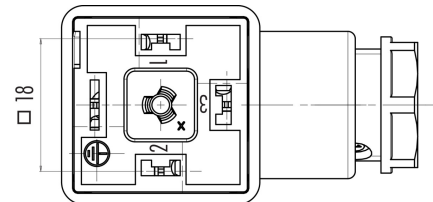

You can find the component part drawing on the next page.

Technical data

General features

Part no.	43 1704 004 03
Connector design	female connector (panel mount)
Version	connector female straight
Connector locking system	central bolt
Termination	screw clamp
Degree of protection	IP40 without seal IP65 with seal, see accessories
Cross-sectional area	min. 0.34 - max. 1.50 mm ²
Cable outlet	3.0 - 10.0 mm
Temperature range from/to	-30 °C / 120 °C
Mechanical operation	> 50 Mating cycles
Weight (g)	25.00
Customs tariff number	85369010

Electrical parameters

Rated voltage	250 V
Rated impulse voltage	4000 V
Rated current (40 °C)	10 A

Product description	Size A female connector (panel mount), Contacts: 2+PE, 3.0 - 10.0 mm, unshielded, screw clamp, IP40 without seal, VDE, ESTI+
Area	Size A series 210
Part no.	43 1704 004 03

Pollution degree	3
Overvoltage category	III
Insulating material group	III
EMC compliance	unshielded

Material

Housing material	PA
Contact body material	PA (UL94 HB)
Contact material	CuSn (bronze)
Contact plating	Ni (nickel)
REACH SVHC	CAS 7439-92-1 (Lead)
SCIP number	SCIP-number not available

Authorization/approvals

Approvals	VDE, ESTI+
-----------	------------

Classifications

eCl@ss 11.1	27-06-03-11
ETIM 7.0	EC001855

Declarations of conformity

Low Voltage Directive	2014/35/EU (EN 60204-1:2018;EN 60529:1991)
-----------------------	--

Automation technology - solenoid valve connectors

Product description	Size A female connector (panel mount), Contacts: 2+PE, 3.0 - 10.0 mm, unshielded, screw clamp, IP40 without seal, VDE, ESTI+
Area	Size A series 210
Part no.	43 1704 004 03

Automation technology - solenoid valve connectors

Product description	Size A female connector (panel mount), Contacts: 2+PE, 3.0 - 10.0 mm, unshielded, screw clamp, IP40 without seal, VDE, ESTI+
Area	Size A series 210
Part no.	43 1704 004 03

Product description	Size A female connector (panel mount), Contacts: 2+PE, 3.0 - 10.0 mm, unshielded, screw clamp, IP40 without seal, VDE, ESTI+
Area	Size A series 210
Part no.	43 1704 004 03

Component part drawing

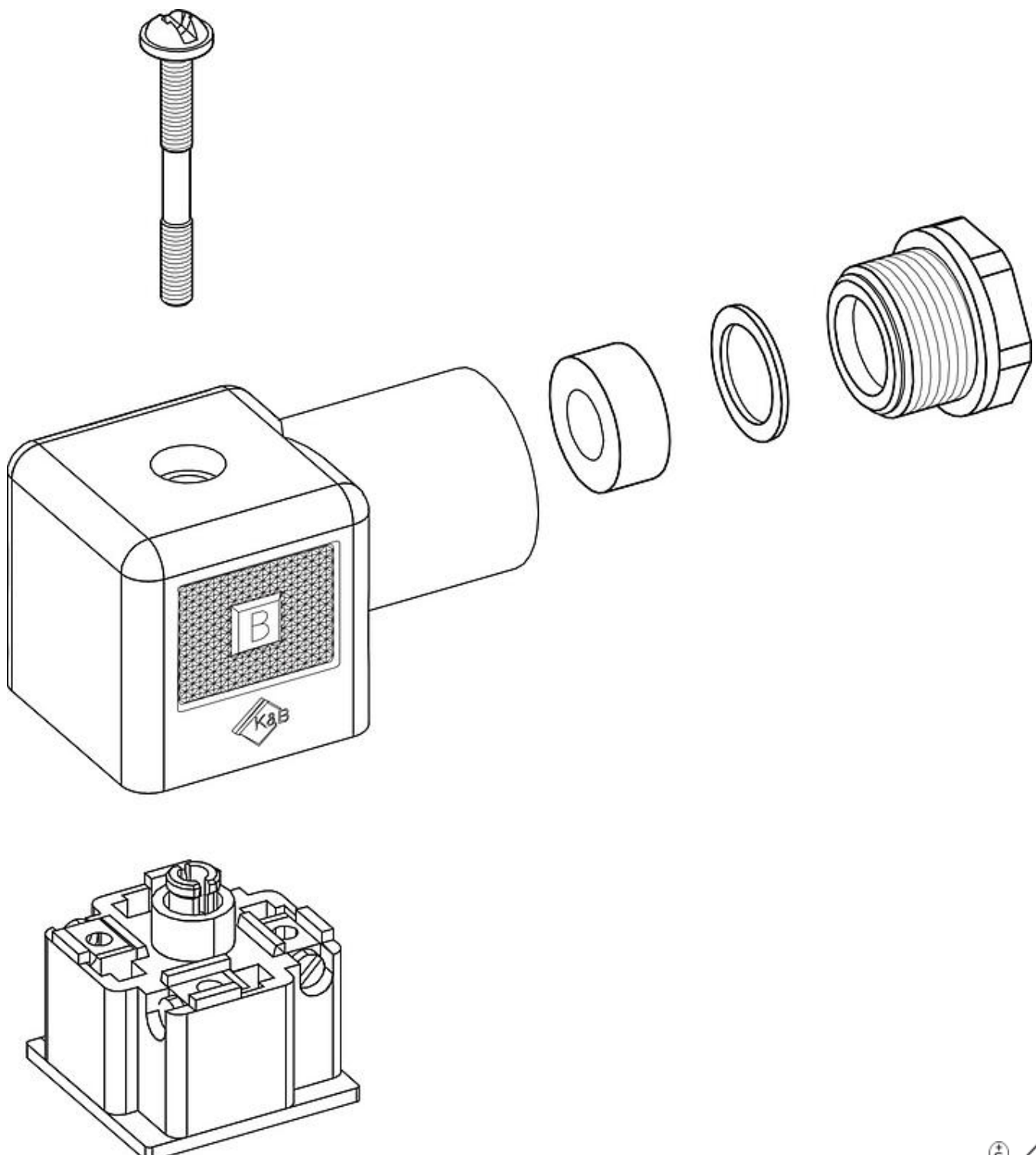

Product description	Size A female connector (panel mount), Contacts: 2+PE, 3.0 - 10.0 mm, unshielded, screw clamp, IP40 without seal, VDE, ESTI+
Area	Size A series 210
Part no.	43 1704 004 03

Security notices

The connector must not be plugged or unplugged under load. Non-observance and improper use can result in personal injury.

The connectors have been developed for applications in plant engineering, control and electrical equipment construction. The user is responsible for checking whether the connectors can also be used in other areas of application.

Connectors which are used in circuits with voltages dangerous to the touch may only be installed and used by, or under the supervision of, persons with electrical engineering training, taking into account the applicable regulations and standards.

Plug connectors with enclosure protection IP 67 and IP 68 are not suitable for use under water. When used outdoors, the plug connectors must be protected separately against corrosion. For further information on the IP protection classes, please refer to the "Technical Information" download centre.

The user must take appropriate safety precautions to ensure that the connector cannot be accidentally disconnected. In addition, the user must ensure that the cable is suitably secured.