

Product description	Size B (industry) connecting cord, Contacts: 2+PE, unshielded, screw clamp, IP67, PUR black, 3 x 0.75 mm ²
Area	Size B (industry) series 220
Order number	79 5717 10 03

Illustration

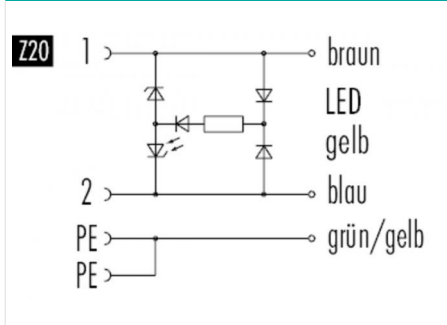

Cable design



Scale drawing

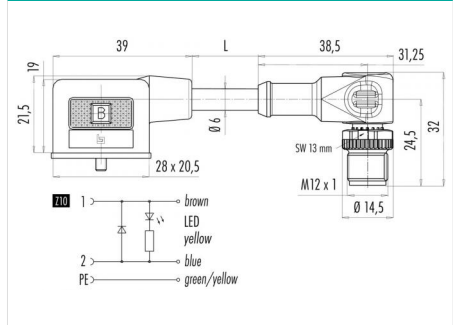

Contact arrangement (Plug-in side)

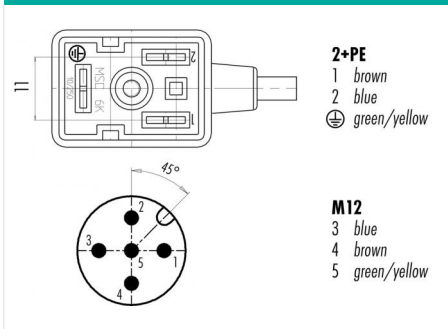

Technical data

General features

Order number	79 5717 10 03
Connector design	connecting cord
Cable length	1 m
Version	connecting cable
Connector locking system	central bolt
Termination	screw clamp
Degree of protection	IP67
Cross-sectional area	0.75 mm ² / AWG 18
Temperature range from/to	-25 °C / 85 °C
Mechanical operation	> 50 Mating cycles
Weight (g)	85.5
Customs tariff number	85444290

Electrical parameters

Rated voltage	24 V
Rated impulse voltage	4000 V
Rated current (40 °C)	4 A
Insulation resistance	≥ 10 ¹⁰ Ω
Pollution degree	3
Overvoltage category	II
Insulating material group	II
EMC compliance	unshielded
Wiring	Z20

Material

Housing material	PC
Contact body material	PA
Contact material	CuSn (bronze) / CuZn (brass)
Contact plating	Sn (tin)
REACH SVHC	CAS 7439-92-1 (Lead)

Product description	Size B (industry) connecting cord, Contacts: 2+PE, unshielded, screw clamp, IP67, PUR black, 3 x 0.75 mm ²
Area	Size B (industry) series 220
Order number	79 5717 10 03

Technical data

Classifications

eCl@ss 11.1	27-06-03-11
ETIM 7.0	EC001855

Declarations of conformity

RoHS Directive	2011/65/EU (EN 50581:2012)
----------------	----------------------------

Cable data

Cable diameter	6.0 mm
Cross section	3 x 0.75 mm ²
Sheath material	PUR
Single-lead insulation	PVC
Single-lead structure	24x0,2 mm
Cable color	black
Temperature range cable in move from/to	-5°C / +70°C
Temperature range cable fixed from/to	-25°C / +70°C
Halogen free	No

Product description	Size B (industry) connecting cord, Contacts: 2+PE, unshielded, screw clamp, IP67, PUR black, 3 x 0.75 mm ²
Area	Size B (industry) series 220
Order number	79 5717 10 03

Security notices

The connectors have been developed for applications in plant engineering, control and electrical equipment construction. The user is responsible for checking whether the connectors can also be used in other areas of application.

Plug connectors with enclosure protection IP 67 and IP 68 are not suitable for use under water. When used outdoors, the plug connectors must be protected separately against corrosion. For further information on the IP protection classes, please refer to the "Technical Information" download centre. The user must take appropriate safety precautions to ensure that the connector cannot be accidentally disconnected. In addition, the user must ensure that the cable is suitably secured.