

Product description	7/8" male cable connector, Contacts: 4+PE, 6.0 - 8.0 mm, unshielded, screw clamp, IP67, UL, VDE
Area	7/8" series 820
Order number	99 2445 12 05

Illustration

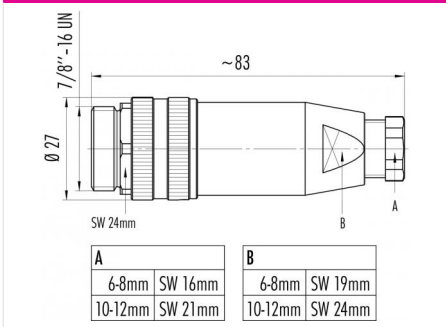

Scale drawing



Contact arrangement (Plug-in side)

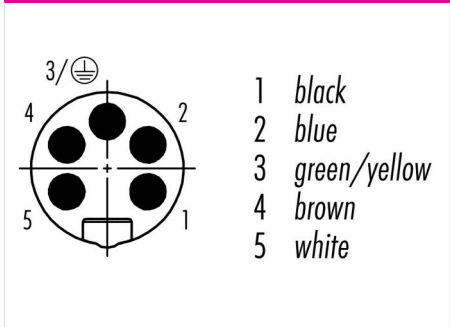

You can find the component part drawing and assembly instructions on the next page.

Technical data

General features

Order number	99 2445 12 05
Connector design	male cable connector
Version	connector male straight
Connector locking system	screw
Termination	screw clamp
Degree of protection	IP67
Cross-sectional area	max. 1.50 mm ² / max. AWG 16
Cable outlet	6.0 - 8.0 mm
Temperature range from/to	-25 °C / 85 °C
Mechanical operation	> 50 Mating cycles
Weight (g)	52.067
Customs tariff number	85369010

Electrical parameters

Rated voltage	300 (UL 600 V) V
Rated impulse voltage	4000 V
Rated current (40 °C)	9 A
Insulation resistance	≥ 10 ¹⁰ Ω
Pollution degree	3
Overvoltage category	III
Insulating material group	III
EMC compliance	unshielded

Material

Housing material	PBT
Contact body material	PUR/PA
Contact material	Pin: CuZn (brass) / Socket: CuSn (bronze) Au (gold)
Contact plating	Zinc die-cast nickel-plated
Locking material	CAS 7439-92-1 (Lead)
REACH SVHC	

Classifications

eCl@ss 11.1	27-44-01-02
ETIM 7.0	EC002635

Declarations of conformity

Low Voltage Directive	2014/35/EU (EN 60204-1:2018;EN 60529:1991)
-----------------------	--

Product description	7/8" male cable connector, Contacts: 4+PE, 6.0 - 8.0 mm, unshielded, screw clamp, IP67, UL, VDE
Area	7/8" series 820
Order number	99 2445 12 05

Component part drawing

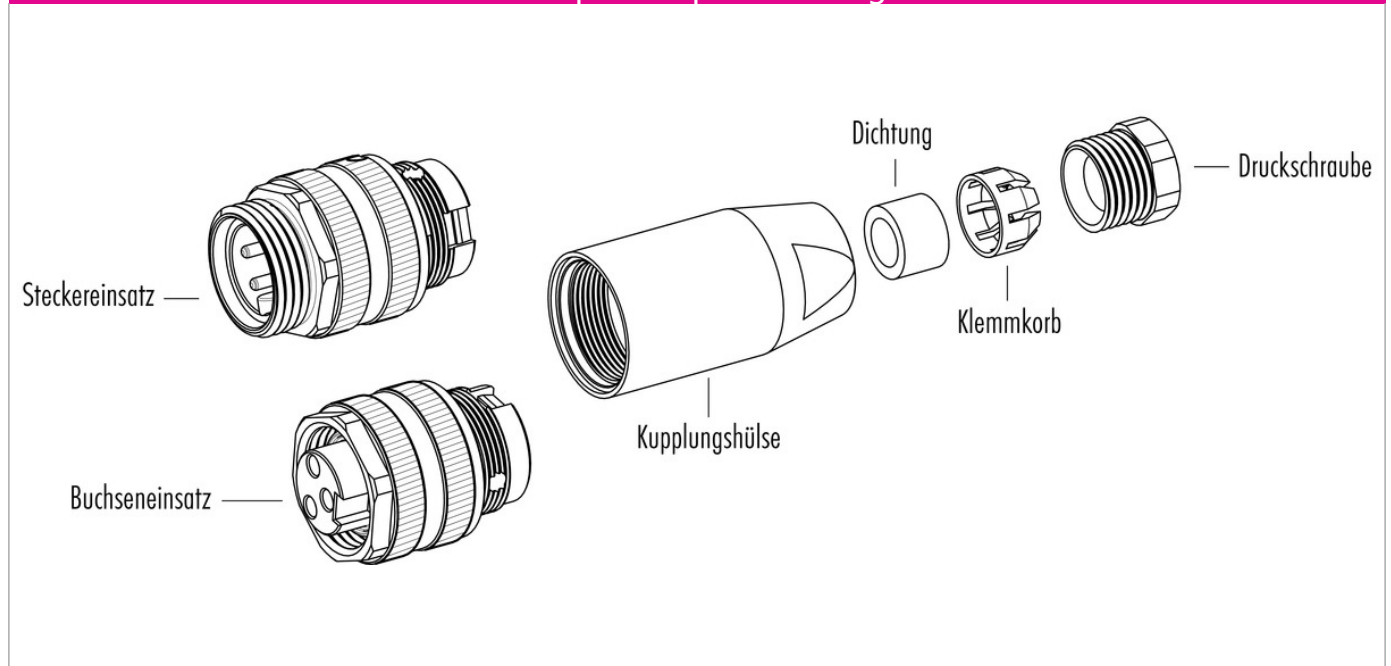

Assembly instructions / Panel cut-out

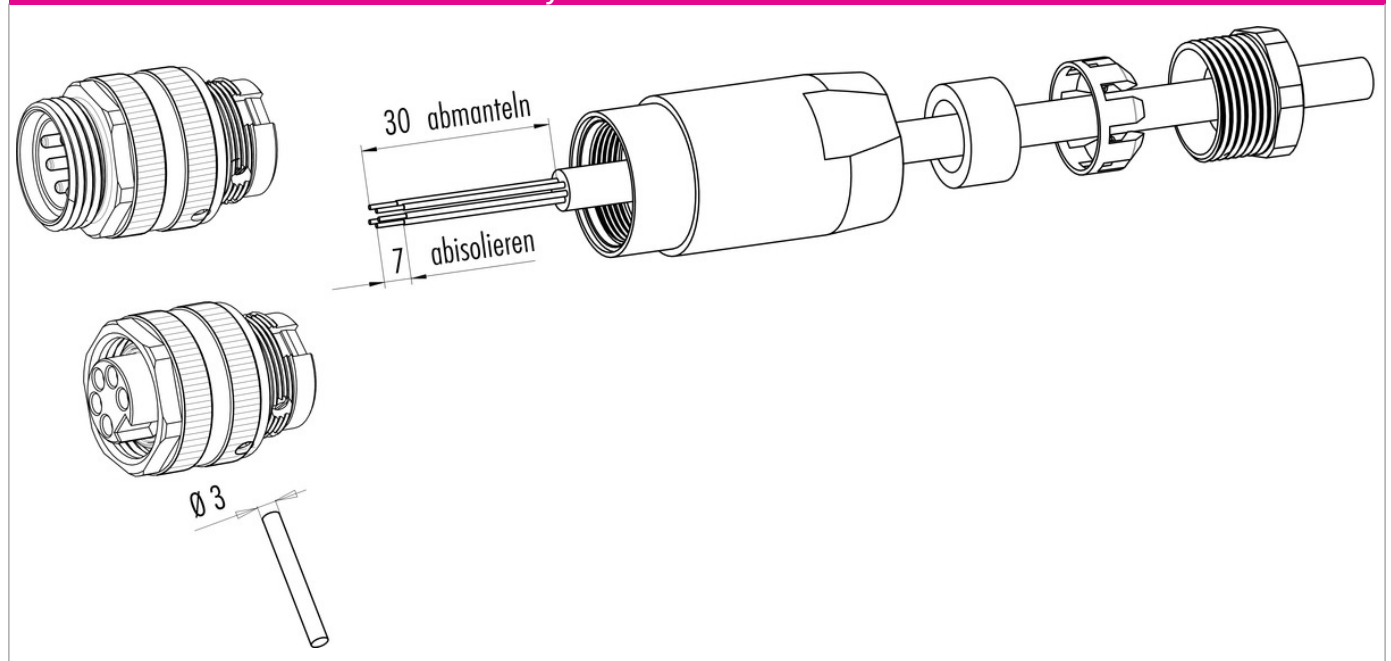

Product description	7/8" male cable connector, Contacts: 4+PE, 6.0 - 8.0 mm, unshielded, screw clamp, IP67, UL, VDE
Area	7/8" series 820
Order number	99 2445 12 05

Security notices

The connector must not be plugged or unplugged under load. Non-observance and improper use can result in personal injury.

The connectors have been developed for applications in plant engineering, control and electrical equipment construction. The user is responsible for checking whether the connectors can also be used in other areas of application.

Connectors which are used in circuits with voltages dangerous to the touch may only be installed and used by, or under the supervision of, persons with electrical engineering training, taking into account the applicable regulations and standards.

Plug connectors with enclosure protection IP 67 and IP 68 are not suitable for use under water. When used outdoors, the plug connectors must be protected separately against corrosion. For further information on the IP protection classes, please refer to the "Technical Information" download centre. To lock the cable connector with the device connector, the threaded ring is tightened "hand-tight" (approx. 50 cNm).