

Product description	M23 male panel mount connector, Contacts: 9, unshielded, solder, IP67, central lock
Area	M23 series 623
Order number	99 4603 20 09

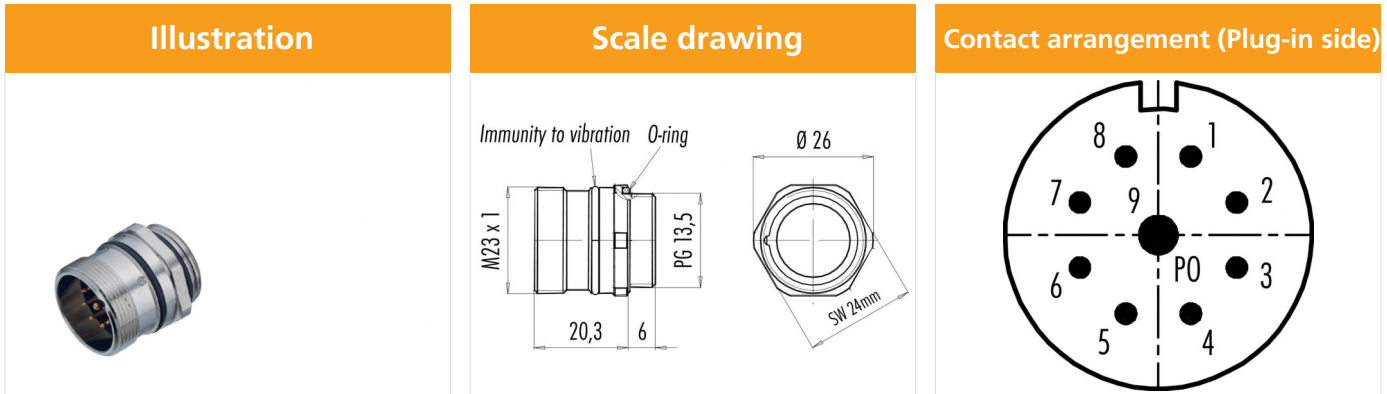

Technical data

General features

Order number	99 4603 20 09
Connector design	male panel mount connector
Version	connector male straight
Connector locking system	screw
Termination	solder
Degree of protection	IP67
Arrangement of contacts	clockwise
Cross-sectional area	8x1.50 / 1x2.50 mm ² / 8x AWG 16 / 1x AWG 14
Temperature range from/to	-25 °C / 125 °C
Mechanical operation	> 50 Mating cycles
Weight (g)	32.11
Customs tariff number	85369010

Classifications

eCl@ss 11.1	27-44-01-02
ETIM 7.0	EC002635

Electrical parameters

Rated voltage	48 V
Rated impulse voltage	2500 V
Rated current (40 °C)	8 x 8 A / 1 x 20 A
Insulation resistance	≥ 10 ¹⁰ Ω
Pollution degree	3
Overvoltage category	II
Insulating material group	III
EMC compliance	unshielded

Material

Housing material	Zinc die-cast nickel-plated
Contact body material	PBT/PA66
Contact material	CuZn (brass)
Contact plating	Au (gold)
REACH SVHC	CAS 7439-92-1 (Lead)

Product description	M23 male panel mount connector, Contacts: 9, unshielded, solder, IP67, central lock
Area	M23 series 623
Order number	99 4603 20 09

Security notices

The connector must not be plugged or unplugged under load. Non-observance and improper use can result in personal injury.

The connectors have been developed for applications in plant engineering, control and electrical equipment construction. The user is responsible for checking whether the connectors can also be used in other areas of application.

Plug connectors with enclosure protection IP 67 and IP 68 are not suitable for use under water. When used outdoors, the plug connectors must be protected separately against corrosion. For further information on the IP protection classes, please refer to the "Technical Information" download centre.