

Product data sheet

Subminiature connectors



Product description	Snap-In IP67 Female panel mount connector, Contacts: 5, unshielded, solder, IP67
Area	Snap-In IP67 series 620
Part no.	99 9216 060 05

Illustration



Scale drawing

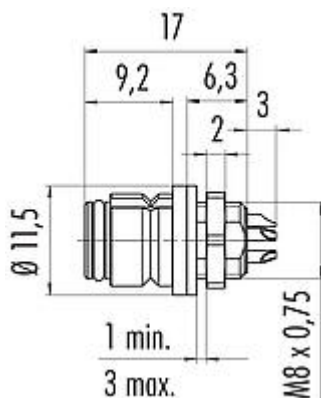

Contact arrangement (Plug-in side)

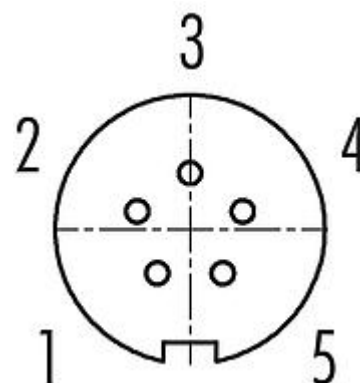

You can find the component part drawing and assembly instructions on the next page.

Technical data

General features

Part no.	99 9216 060 05
Connector design	Female panel mount connector
Version	Connector socket straight
Connector locking system	snap-in
Termination	solder
Degree of protection	IP67
Cross-sectional area	max. 0.25 mm ² / AWG 24
Temperature range from/to	-25 °C / 85 °C
Tightening torque screw nut	0.5 Nm
Mechanical operation	> 500 Mating cycles
Weight (g)	2.67
Customs tariff number	85369010

Electrical parameters

Rated voltage	63 V
Rated impulse voltage	800 V
Rated current (40 °C)	2.0 A
Insulation resistance	≥ 10 ¹⁰ Ω
Pollution degree	2
Overvoltage category	II
Insulating material group	II
EMC compliance	unshielded

Product data sheet

Subminiature connectors

Product description	Snap-In IP67 Female panel mount connector, Contacts: 5, unshielded, solder, IP67
Area	Snap-In IP67 series 620
Part no.	99 9216 060 05

Material

Housing material	PA
Contact body material	PA (UL94 HB) blue
Contact material	CuSn (bronze)
Contact plating	Au (gold)
REACH SVHC	CAS 7439-92-1 (Lead)
SCIP number	SCIP-number not available

Classifications

eCl@ss 11.1	27-44-01-02
ETIM 7.0	EC002635

Component part drawing

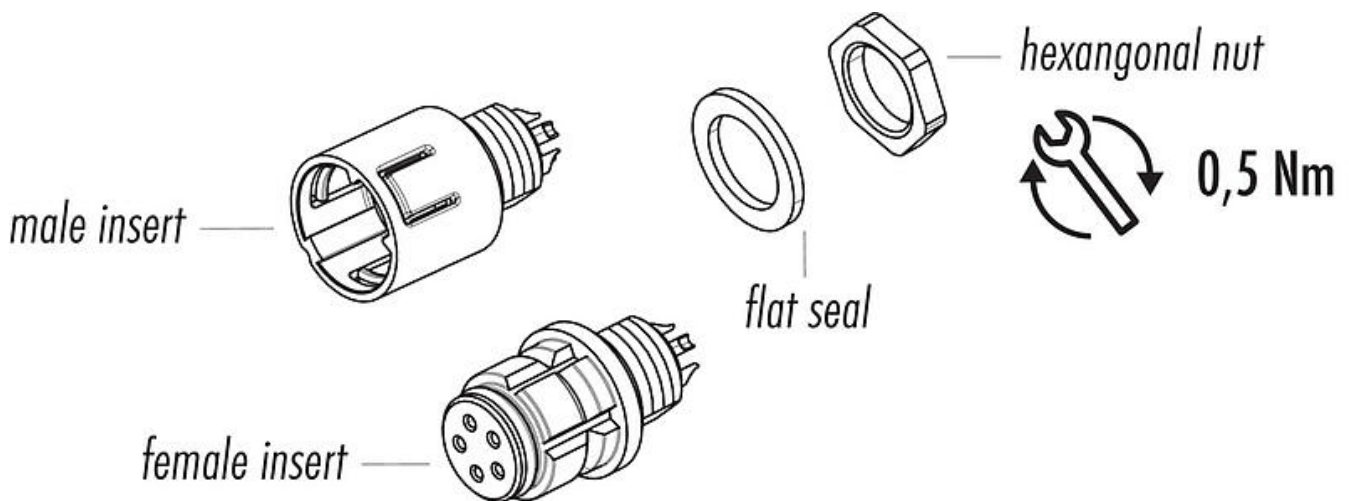

Product description	Snap-In IP67 Female panel mount connector, Contacts: 5, unshielded, solder, IP67
Area	Snap-In IP67 series 620
Part no.	99 9216 060 05

Assembly instructions / Panel cut-out

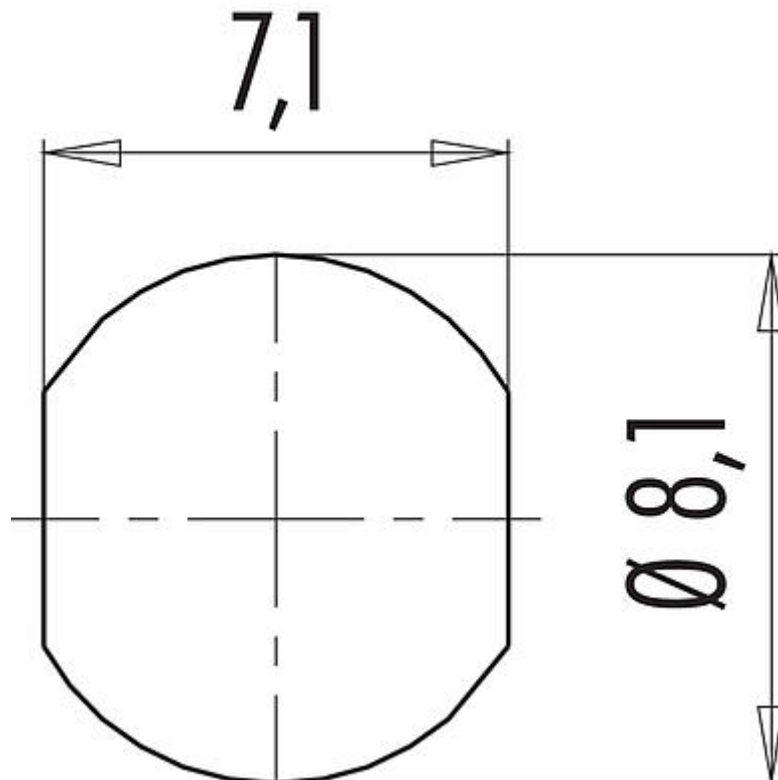

Product description	Snap-In IP67 Female panel mount connector, Contacts: 5, unshielded, solder, IP67
Area Part no.	Snap-In IP67 series 620 99 9216 060 05

Security notices

The connector must not be plugged or unplugged under load. Non-observance and improper use can result in personal injury.

The connectors have been developed for applications in plant engineering, control and electrical equipment construction. The user is responsible for checking whether the connectors can also be used in other areas of application.

To protect against unintentional opening of the connector, the thread between the housing and the connector head must be secured with a suitable cyanoacrylate adhesive when used in circuits with voltages dangerous to the touch. This does not apply to connectors used in SELV and PELV circuits according to IEC 61140 (EN 61140, VDE 0140-1).

Connectors which are used in circuits with voltages dangerous to the touch may only be installed and used by, or under the supervision of, persons with electrical engineering training, taking into account the applicable regulations and standards.

Plug connectors with enclosure protection IP67 and IP68 are not suitable for use under water. When used outdoors, the plug connectors must be protected separately against corrosion. For further information on the IP protection classes, please refer to the "Technical Information" download centre.